











WOOD-SPECIALTIES
(BY ARRAN HOLDINGS LTD)
WEBSITE: WWW.WOOD-SPECIALTIES.COM

#308 14640 64TH AVE
 SURREY BC V3S 1X7
 PH. 1-888-243-7555
 PH. (604) 597-3985
 FAX (604) 597-3968

OCT 2015

PAGE C-1
 VICTORIAN







ITEM	DESCRIPTION & ORDER #	ITEM	DESCRIPTION & ORDER #
	<p>ED1</p> <p>CLEAR PINE 6" X 10" X 3/4" HANDCUT BRACKET</p>		<p>ED4F</p> <p>CLEAR PINE 13-1/2" X 21" X 1-1/2" HANDCUT BRACKET WITH 1X2 FRAME</p>
	<p>ED1F</p> <p>CLEAR PINE 7" X 11" X 1-1/2" HANDCUT BRACKET WITH 1X2 FRAME</p>		<p>AB815</p> <p>8" X 15" X 3/4" PINE ARCH BRACKET</p> <p>GREAT FOR SCREEN DOORS!!</p> <p>2 PCS SHOWN</p>
	<p>ED2</p> <p>CLEAR PINE 8" X 14" X 3/4" HANDCUT BRACKET</p>		<p>AB815F</p> <p>8" X 15" X 1-1/2" PINE ARCH BRACKET C/W 1X2 FRAME</p>
	<p>ED2F</p> <p>CLEAR PINE 9" X 14" X 1-1/2" HANDCUT BRACKET WITH 1X2 FRAME</p>		<p>FB1010</p> <p>10" X 10" X 3/4" FAN BRACKET MADE FROM LAMINATED PINE</p>
	<p>ED3F</p> <p>CLEAR PINE 12" X 16-1/2" X 1-1/2"</p> <p>HANDCUT BRACKET WITH 1X2 FRAME "HEART DESIGN"</p> <p>EXCELLENT FOR PORCHES AVAILABLE UNFRAMED AS WELL FOR SCREEN DOORS</p>		<p>FB1115</p> <p>11" X 15" X 3/4" FAN BRACKET MADE FROM LAMINATED PINE</p>



WOOD-SPECIALTIES
(BY ARRAN HOLDINGS LTD)
WEBSITE: WWW.WOOD-SPECIALTIES.COM

#308 14640 64TH AVE
 SURREY BC V3S 1X7
 PH. 1-888-243-7555
 PH. (604) 597-3985
 FAX (604) 597-3968

OCT 2015

PAGE C-2
 VICTORIAN

ITEM	DESCRIPTION & ORDER #
	FB58 5" X 8" X 3/4" PINE FAN BRACKET GREAT FOR SCREEN DOOR CORNERS
	FB812 8" X 12" X 3/4" LAMINATED PINE FAN BRACKET
	FB1616F 16" X 16" X 1-1/2" LAMINATED PINE FAN BRACKET 3/4" THICK WITH A 1X2 FRAME
	PP15 9" X 14" X 1-1/4" PINE PORCH POST BRACKET
	PP15F 11" X 16" X 2" PINE PORCH POST BRACKET 1-1/4" THICK WITH A 2" FRAME
	PP18 9" X 12-1/2" X 1-1/4" PINE PORCH POST BRACKET



ITEM	DESCRIPTION & ORDER #
	AB1325 13" X 24" X 1-1/2" PINE PORCH POST BRACKET 3/4" PINE WITH A 1X2 FRAME
	WP4 20" X 20" X 1-1/2" PINE BRACKET 3/4" LAMINATED KNOTTY PINE C/W 1X2 PINE FRAME
	WP5 9" X 22" X 1-1/2" PINE BRACKET 3/4" LAMINATED KNOTTY PINE C/W 1X2 PINE FRAME

WOOD-SPECIALTIES
(BY ARRAN HOLDINGS LTD)
WEBSITE: WWW.WOOD-SPECIALTIES.COM

#308 14640 64TH AVE
 SURREY BC V3S 1X7
 PH. 1-888-243-7555
 PH. (604) 597-3985
 FAX (604) 597-3968

OCT 2015

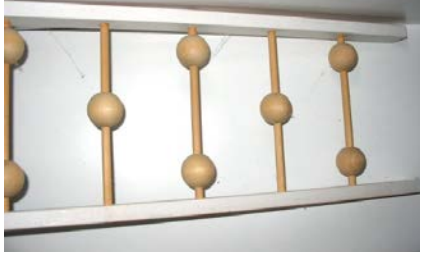
PAGE C-3
 VICTORIAN

ITEM	DESCRIPTION & ORDER #
	<p>BALL & DOWEL SPANDREL CUSTOM MADE TO YOUR EXACT LENGTHS!!</p> <p>7" HIGH (SINGLE CENTER BALL) SPAN7 9" HIGH (AS SHOWN) SPAN9 11" HIGH (AS SHOWN) SPAN11</p>
	<p>CLUB1 RUNNING TRIM FOR GABLES</p> <p>7" HIGH X 7' LONG</p>

WOOD-SPECIALTIES
(BY ARRAN HOLDINGS LTD)
WEBSITE: WWW.WOOD-SPECIALTIES.COM

#308 14640 64TH AVE
SURREY BC V3S 1X7
PH. 1-888-243-7555
PH. (604) 597-3985
FAX (604) 597-3968

OCT 2015

PAGE C-4
VICTORIAN

VICTORIAN GABLE ORNAMENTS

GABLE ORNAMENTS CAN BE ORDERED UNASSEMBLED OR ASSEMBLED WITH CENTER DROP MOUNTED. PLEASE SPECIFY WHEN ORDERING. WE USUALLY LEAVE EXTRA STOCK ON THE INSIDE WHEN ORDERED UNASSEMBLED WHICH GETS TRIMMED WHEN CUTTING THE PROPER ANGLE FOR ROOF PITCH. IF THEY ARE TO BE MOUNTED UNASSEMBLED SPECIFY AND WE WILL SHIP WITHOUT EXTRA STOCK. THANK YOU.



WP1A - 12" x 36" x 3/4"
LAMINATED PINE
C/W 1X2 MOUNTING STRIP
SHOWN ASSEMBLED
WITH 2X2 CENTRE DROP

ASSEMBLED

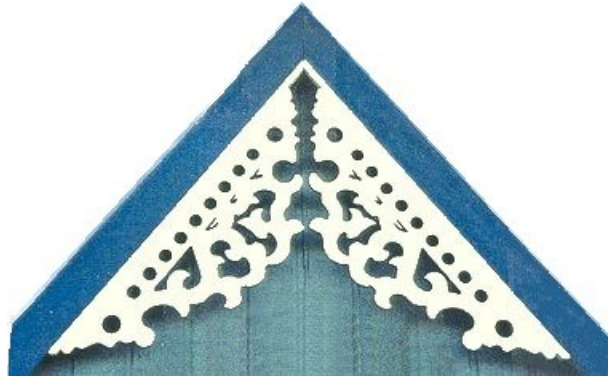

WP1 - 18" x 60" x 3/4" LAMINATED PINE
C/W 1X2 MOUNTING STRIP
SHOWN UNASSEMBLED



WP6 - 9 1/2" x 72" x 1-1/4" SOLID PINE
1-1/2" WIDE FRAME C/W 1-1/2"
HARDWOOD BALLS 2 PCS/ SET



WP7 - 18" x 44" x 3/4"
LAMINATED PINE
C/W 1X2 MOUNTING STRIP
UNASSEMBLED
ASSEMBLED

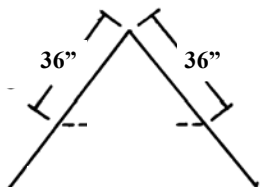

Determining
pitch and an
easy method
of doing so!

Pitch is the number of inches the roof rises vertically for each foot horizontally.

An easy method to determine a pitch is to:

1. Start at the peak, measure down 36" along each side of your gable and make a mark.
2. Measure the distance horizontally "across" from mark to mark. This horizontal measurement must be included with the order, when ordering assembled products.

WOOD-SPECIALTIES
(BY ARRAN HOLDINGS LTD)
WEBSITE: WWW.WOOD-SPECIALTIES.COM

#308 14640 64TH AVE
SURREY BC V3S 1X7
PH. 1-888-243-7555
PH. (604) 597-3985
FAX (604) 597-3968

OCT 2015

PAGE C-5
VICTORIAN



WP9 GABLE ORNAMENT
(9/12 PITCH SHOWN)

4 PCS.(2 SIDES FRAMED, 1 CENTRE SUPPORT, 1 TOP KEY
ADJUSTABLE TO FIT DIFFERENT PITCHES. SOME ASSEMBLY REQUIRED.



GABLE SPIRES
MOUNT ON HOUSE GABLE ENDS
MADE WITH WESTERN RED
CEDAR

SPIRE46	SPIRE48	SPIRE36	SPIRE640	SPIRE636
4X4-46"	4X4-48"	4X4-36"	6X6-40"	6X6-36"

KNEE BRACES

* ALL BRACES GLUED & LAG BOLTED FROM BACK * ANY STYLE CAN BE MADE WITH ANY END DETAIL
 * STRUCTURAL BRACES ARE NOTCHED * BASE PRICES FOR UP TO 36" X 36" KNEE BRACE



BRACE 45 4X4 CEDAR
BEVEL ENDS
24" X 24" SHOWN



BRACE 65
4X4 CEDAR COVE ENDS
30" X 30" SHOWN

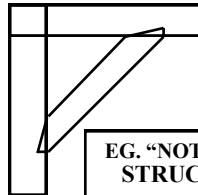

EG. "NOTCHED FOR
 STRUCTURAL"

BRACE 45 21" X 30" FIR SQUARE ENDS	BRACE 35 28" X 32" CEDAR COVE ENDS	BRACE 25 36" X 36" CEDAR CROWN ENDS
---	---	--

BRACE STYLE	4X4 CEDAR GRN CLEAR S4S NET 3-1/2"	6X6 S4S FIR GRN STD/BTR S4S NET 5-1/2"	6X6 CEDAR GRN STK S4S NET 5-1/2"	
BRACE 45 FOR UP TO 48" X 48" — NOTCHED FOR STRUCTURAL— SMALLER BRACE45 UP TO 18" X 18"				
BRACE 65 ADD ON FOR UP TO 48" X 48" — NOTCHED FOR STRUCTURAL — NOTE: CURVED ON FRONT ONLY IF MADE FOR STRUCTURAL				
BRACE 25 36" X 36"				
BRACE 35 28" X 32" FOR OTHER SIZES —				
BRACE 70 SAME AS BRACE 65 "EXCEPT CURVED ONLY ON FRONT"				

WOOD-SPECIALTIES
(BY ARRAN HOLDINGS LTD)
WEBSITE: WWW.WOOD-SPECIALTIES.COM

#308 14640 64TH AVE
 SURREY BC V3S 1X7
 PH. 1-888-243-7555
 PH. (604) 597-3985
 FAX (604) 597-3968

OCT 2015

PAGE C-7
 KNEE BRACES

**WOOD KNEE BRACES. AVAILABLE IN 4X4 CLEAR CEDAR, 6X6 STD/BTR FIR
 6X6 STK CEDAR. MADE TO ANY SIZE AND STYLE!!**

			
BRACE45 STOCK SIZE 21" X 30" 24" X 24"	BRACE65 STOCK SIZE 30" X 30"	BRACE32 28"X 32" SHOWN	BRACE25 36"X 36" SHOWN

		
BRACE52 SMALL SIZE BRACES STOCKED IN ORDER # 12"X12" = KB521212 16"x16" = KB521616 18"X18" = KB521818 4X4 CLEAR CEDAR	BRACE53 SMALL SIZE BRACES STOCKED IN: ORDER # 12"X12" = KB531212 16"X16" = KB531616 18"X18" = KB531818 4X4 CLEAR CEDAR	BRACE54 SMALL SIZE BRACES STOCKED IN: ORDER # 12"X12" = KB541212 16"X16" = KB541616 18"X18" = KB541818 4X4 CLEAR CEDAR





WOOD-SPECIALTIES
(BY ARRAN HOLDINGS LTD)
WEBSITE: WWW.WOOD-SPECIALTIES.COM

#308 14640 64TH AVE
 SURREY BC V3S 1X7
 PH. 1-888-243-7555
 PH. (604) 597-3985
 FAX (604) 597-3968

OCT 2015

PAGE C-8
 KNEE BRACES

**WOOD KNEE BRACES. AVAILABLE IN 4X4 CLEAR CEDAR, 6X6 STD/BTR FIR
 6X6 STK CEDAR. MADE TO ANY SIZE AND STYLE!!**

			
<p>BRACE45D</p> <p>MADE TO ORDER SAME AS BRACE45 WITH DADOE ON VERTICAL PIECE</p>	<p>BRACE70</p> <p>SIMILAR TO BRACE 65</p> <p>STRAIGHT BACK CURVED FRONT</p>	<p>BRACE90</p> <p>MADE TO ORDER SHOWN IS 32" DEEP X 32" HIGH 6X6 CEDAR</p>	<p>BRACE65 FIR G/LAM</p> <p>28" X 32" X 5" THICK BRACE65 STYLE BEAD TOP/ BEVEL ON BACK PIECE LAMINATED SELECT TIGHT KNOT FIR</p>

			
<p>CUSTOM BRACE</p> <p>4X6 BACK ON 2X8 6X6 TOP & DIAGONAL</p>	<p>CUSTOMBRACE</p> <p>32"X 48" X 5-1/2" THICK NOTCHED FOR STRUCTURAL</p>	<p>CUSTOM BRACE</p> <p>32" X 48" X 5" THICK LAMINATED FIR</p>	<p>CUSTOM BRACE</p> <p>36"X 48" X 5" THICK NOTCHED FOR STRUCTURAL</p>

WOOD-SPECIALTIES
(BY ARRAN HOLDINGS LTD)
WEBSITE: WWW.WOOD-SPECIALTIES.COM

#308 14640 64TH AVE
 SURREY BC V3S 1X7
 PH. 1-888-243-7555
 PH. (604) 597-3985
 FAX (604) 597-3968

OCT 2015

PAGE C-9
 CORBELS

**WOOD CORBELS AVAILABLE IN PINE, OAK, MAPLE, CHERRY!!
 CUSTOM SIZES AVAILABLE!! CORBELS CAN BE MADE IN ANY THICKNESS!!**

				
DENTAL3X4 2-3/4" X 4" DENTAL BLOCKS DENTAL512 DENTAL312	CORB33CEDAR 3" W X 3-1/2" D X 8" H EXCELLENT FOR DENTAL BLOCKS	CORB5 4" DEEP X 5" WIDE X 8" HIGH	CORB6 4-1/2" DEEP X 5-1/2" WIDE X 8-1/2" HIGH	CORB10 7" DEEP X 5-1/2" WIDE X 10" HIGH
				
CORB44 6-1/2" DEEP X 2-1/2" WIDE X 10" HIGH	CORB80 4-3/4" DEEP X 3-3/4" WIDE X 10" HIGH	CORB85 4-3/4" D X 5" W X 10" H THICKER VERSION OF CORB80	CORB25 5-1/2" D X 3-3/4" W X 12" H SAME AS CORB 40 WITH LESS DEPTH	CORB18 5" Deep X 5" Wide X 8" High
				
CORB35 7-1/2" DEEP X 3-3/4" WIDE X 12" HIGH	CORB40 9" DEEP X 3-3/4" WIDE X 12" HIGH	CORB90 9" D X 3-3/4" W X 7" H FOR UNDER BAR TOPS	CORB91 8" DEEP X 6" WIDE X 12" HIGH	











WOOD-SPECIALTIES
(BY ARRAN HOLDINGS LTD)
 WEBSITE: WWW.WOOD-SPECIALTIES.COM

#308 14640 64TH AVE
 SURREY BC V3S 1X7
 PH. 1-888-243-7555
 PH. (604) 597-3985
 FAX (604) 597-3968

OCT 2015

PAGE C-10
 CORBELS

WOOD CORBELS AVAILABLE IN PINE, OAK, MAPLE, CHERRY!!
CUSTOM SIZES AVAILABLE!! CORBELS CAN BE MADE IN ANY THICKNESS!!

				
CORB12 5-1/2" DEEP X 3-3/4" WIDE X 16" HIGH	CORB14 9" DEEP X 3-3/4" WIDE X 16" HIGH	CORB50 11" DEEP X 5" WIDE X 18" HIGH	CORB51 11" DEEP X 5" WIDE X 24" HIGH	CORB55GL 11" DEEP X 5" WIDE X 18" HIGH LAMINATED STK FIR
				
CORB65 9" DEEP X 5" WIDE X 10" HIGH	CORB95 8" DEEP X 7-1/2" WIDE X 9-1/4" HIGH	CORB816 8" DEEP X 5" WIDE X 16" HIGH LAMINATED STK FIR	CORB60 11" DEEP X 5" WIDE X 18" HIGH	CORB916 CLEAR CEDAR 9" DEEP X 9" WIDE X 16" HIGH

WOOD-SPECIALTIES
(BY ARRAN HOLDINGS LTD)
WEBSITE: WWW.WOOD-SPECIALTIES.COM





#308 14640 64TH AVE
 SURREY BC V3S 1X7
 PH. 1-888-243-7555
 PH. (604) 597-3985
 FAX (604) 597-3968

OCT 2015

PAGE C-11
 CORBELS

WOOD CORBELS AVAILABLE IN PINE, OAK, MAPLE, CHERRY!!
CUSTOM SIZES AVAILABLE!! CORBELS CAN BE MADE IN ANY THICKNESS!!

SMALLER CORBELS OR "DENTAL BLOCKS"

				
CORB32 3-3/4" DEEP X 3-1/2" WIDE X 4-1/2" HIGH	CORB34 4" DEEP X 3" WIDE X 5-1/2" HIGH	CORB38 5-1/2" DEEP X 5" WIDE X 5-1/2" HIGH	CORB39 6" DEEP X 3-1/2" WIDE X 7-1/4" HIGH	CORB95C 3-1/2" DEEP X 5" WIDE X 6" HIGH

LARGER CUSTOM CORBELS

RAFTER EXTENSIONS CEDAR OR FIR
 MADE TO CUSTOM LENGTHS



CUSTOM CORBEL
"MAHOGANY"
 8" DEEP X 6-1/2"
 WIDE X 24" HIGH

CALL FOR
 PRICING

Corb511
 11" d x 12"h x 5"w

Shown in pine



Corb516 16x16x5"



RAFT36

SIZE SHOWN
 3-1/2"X5-1/2" X 16"



RAFT35

SIZE SHOWN
 3-1/2"X5-1/2" X 18"



RAFT410

SIZE SHOWN
 3-1/2"X9-1/4" X 20"

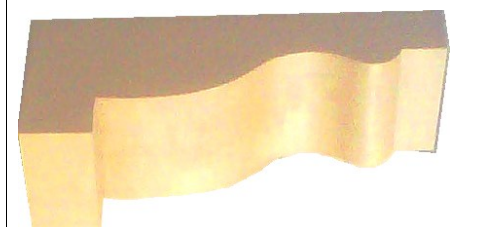

RAFT66

SIZE SHOWN
 5-1/2"X5-1/2"X 20"